

WARNING

- Battery packs may explode or release toxic materials. Risk of fire or burns. Do not open, crush, modify, disassemble, heat above 140°F (60°C), or incinerate.
- Follow instructions from manufacturer
- Only use Shure charger to recharge Shure rechargeable batteries
- **WARNING:** Danger of explosion if battery incorrectly replaced. Replace only with same or equivalent type.
- Never put batteries in mouth. If swallowed, contact your physician or local poison control center
- Do not short circuit; may cause burns or catch fire
- Do not charge or use battery packs other than Shure rechargeable batteries
- Dispose of battery packs properly. Check with local vendor for proper disposal of used battery packs.
- Batteries (battery pack or batteries installed) shall not be exposed to excessive heat such as sunshine, fire or the like

Note: Use only with the included power supply or a Shure-approved equivalent.

WARNING: Danger of explosion if incorrect battery replaced. Operate only with AA batteries.

Please follow your regional recycling scheme for batteries, packaging, and electronic waste.

WARNING: This product contains a chemical known to the State of California to cause cancer and birth defects or other reproductive harm.

低功率電波輻射性電機管理辦法

第十二條

經型式認證合格之低功率射頻電機，非經許可，公司、商號或使用者均不得擅自變更頻率、加大功率或變更原設計之特性及功能。第十四條

低功率射頻電機之使用不得影響飛航安全及干擾合法通信；經發現有干擾現象時，應立即停用，並改善至無干擾時方得繼續使用。前項合法通信，指依電信法規定作業之無線電通信。低功率射頻電機須忍受合法通信或工業、科學及醫療用電波輻射性電機設備之干擾。

AD2 Handheld Transmitter

AD series hand-held transmitters deliver impeccable audio quality and RF performance with wide-tuning, High Density (HD) mode, and encryption. The

transmitter features durable metal construction, AA or SB900A rechargeable power (with dockable charging), and black or nickel finish options.

Features

Performance

- 20 Hz to 20 kHz range with flat frequency response
- Automatic input staging optimizes gain setting
- AES 256-bit encryption-enabled for secure transmission
- >120 dB dynamic range
- 100 meter (300 feet) line-of-sight operating range
- Selectable modulation modes optimize performance for spectral efficiency or audio quality:
 - Standard – optimal coverage, low latency
 - High density – dramatic increase in max system channel count
- Switchable Power Levels = 2/10/35 mW (region dependent)
- Built-in tone generator and RF markers to facilitate range-testing

Design

- Interchangeable Shure microphone cartridges
- Backlit LCD with easy to navigate menu and controls
- Rugged metal construction
- Menu and power lockout

Power

- Up to 8 hours continuous use with 2 x AA alkaline batteries
- Shure SB900A lithium-ion rechargeable battery provides extended battery life, precision metering, and zero memory effect
- External charging contacts for docked charging

Included Components

Zipper Bag	95B2313
Euro-Threaded Adapter	31B1856
Swivel Adapter, black	90F4046
AA Alkaline Battery (2)	80B8201

Choice of (1) of the following Shure microphone cartridges:

SM58 (RPW112)	KSM9 Nickel (RPW188)
BETA 87C (RPW122)	BETA 87A (RPW120)
BETA 58A (RPW 118)	KSM9 Black (RPW184)
KSM8 Black (RPW174)	KSM8 Nickel (RPW170)
KSM9HS Black (RPW186)	KSM9HS Nickel (RPW190)

Optional Accessories

SB900A Rechargeable lithium-ion battery	SB900A
Radome Color ID Kit for AD2	WA617M
Battery Contact Cover for AD2	WA618
Microphone stand adapter	WA371

Optional Shure microphone cartridges:

- SM58** (RPW112)
- SM86** (RPW114)
- SM87A** (RPW116)
- BETA 58A** (RPW118)
- BETA 87A** (RPW120)
- BETA 87C** (RPW122)
- VP68** (RPW124)
- KSM9 Nickel** (RPW188)
- KSM9HS Nickel** (RPW190)
- KSM9 Black** (RPW184)
- KSM9HS Black** (RPW186)

Transmitters

① Microphone Cartridge

See Optional Accessories for a list of compatible cartridges.

② Display

View menu screens and settings. Press any control button to activate the backlight.

③ Infrared (IR) Port

Align with the receiver IR port during an IR Sync for automated transmitter programming.

④ Menu Navigation Buttons

Use to navigate through parameter menus and change values.

⑤ Battery Compartment

Requires Shure SB900A rechargeable battery or 2 AA batteries.

⑥ AA Battery Adapter

Remove to accommodate a Shure SB900A battery.

⑦ On/Off Switch

Powers the unit on or off.

⑧ Battery Door

Latch to secure batteries.

⑨ Handle

Unscrew to access controls and batteries.

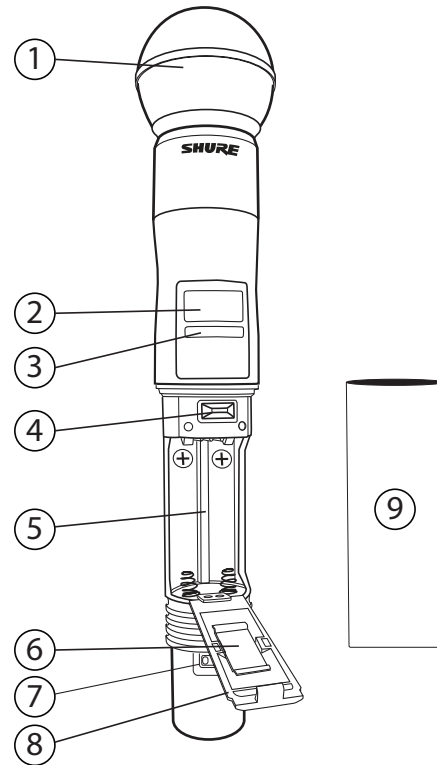

Transmitter Controls

Use to navigate through parameter menus and change values.

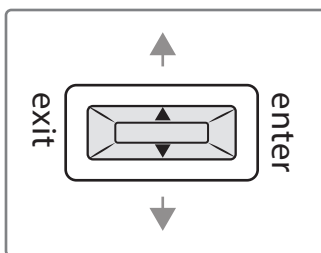

exit	Acts as a 'back' button to return to previous menus or parameters without confirming a value change
enter	Enters menu screens and confirms parameter changes
∨∧	Use to scroll through menu screens and to change parameter values

Home Screen Display

The home screen shows transmitter information and status.

Tip: There are four options to choose the information shown on the home screen. Use the arrow buttons to select one of the following choices:

- Name
- Frequency Setting
- Group (G) and Channel (C)
- Device ID

The following icons appear to indicate transmitter settings:

- Battery runtime in hours and minutes or bar display
- Key: Displayed when encryption is enabled

- Lock: Displayed when controls are locked
- STD: Standard Transmission Mode
- HD: High Density Transmission Mode
- Box: When the box has an "x", Mute Mode is on and engaged. If the box is empty, Mute Mode is on, but not engaged.

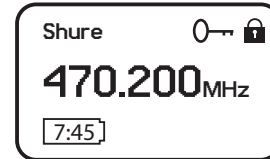

Locking the Controls

Lock transmitter controls to prevent accidental or unauthorized changes to parameters. The lock icon is shown on the home screen when the control lock is enabled.

1. From the Utilities menu, navigate to Lock and select one of the following:
 - Locked: Locks the controls
 - Unlocked: Unlocks the controls
2. Press enter to save.

Tip: To quickly unlock a transmitter: Press enter, select Unlocked, and press enter.

Battery Installation

①

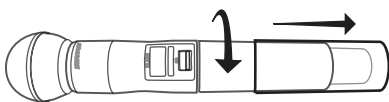

②

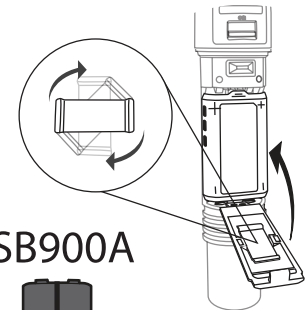
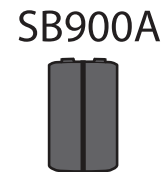
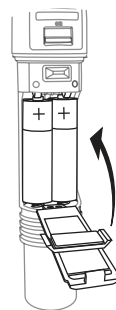

① Accessing the Battery Compartment

Unscrew the cover on the transmitter as shown to access the battery compartment.

② Installing Batteries

- **AA Batteries:** Place batteries (note polarity markings) and AA Adapter as shown. Close the door to secure the batteries.
- **Shure SB900A Battery:** Place battery as shown (note polarity markings). Remove the AA adapter and stow it in the door. Close the door to secure the battery.

Note: If using AA batteries, set the battery type using the transmitter menu.

Setting the AA Battery Type

To ensure accurate display of transmitter runtime, set the battery type in the transmitter menu to match the installed AA battery type.

Note: If a Shure SB900A rechargeable battery is installed, selecting a battery type is not necessary and the battery type will display Shure.

1. Navigate to the Utilities and select Battery.
2. Use the ▼▲ buttons to select the installed battery type:
 - Alkaline = Alkaline
 - NiMH = Nickel Metal Hydride
 - Lithium = Lithium Primary
3. Press enter to save.

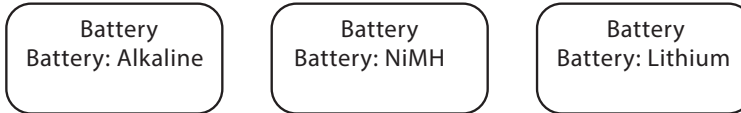

Updating Firmware

Firmware is embedded software in each component that controls functionality. Periodically, new versions of firmware are developed to incorporate additional features and enhancements. To take advantage of design improvements, new versions of the firmware can be uploaded and installed using the Shure Update Utility. The Shure Update Utility is available for download from <http://www.shure.com/>.

Firmware Versioning

When performing an update, download firmware to the receiver first, and then update transmitters to the same firmware version to ensure consistent operation.

The firmware numbering for Shure devices uses the following format: MAJOR.MINOR.PATCH (e.g., 1.2.14). At a minimum, all devices on the network (including transmitters), must have the same MAJOR and MINOR firmware version numbers (e.g., 1.2.x).

Updating the Transmitter

1. To upload the firmware to the transmitter, go to Device Configuration>Tx Firmware Update on the receiver.
2. Place the transmitter on its side and align the IR ports.
3. Press ENTER on the receiver to begin the download to the transmitter. IR ports must be aligned for the entire download, which can take 50 seconds or longer.

Shure SB900A Rechargeable Battery

Shure SB900A lithium-ion batteries offer a rechargeable option for powering the transmitters. Batteries quickly charge to 50% capacity in one hour and reach full charge within three hours.

Single chargers and multiple bay chargers are available to recharge the Shure batteries.

Caution: Only charge Shure rechargeable batteries with a Shure battery charger.

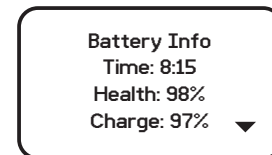

Shure SB900A Runtime

2 mW	10 mW	35 mW
Up to 9 hours	Up to 9 hours	Up to 5 hours

Checking Battery Info

When using an SB900A rechargeable battery, the receiver and transmitter home screens display the number of hours and minutes remaining.

Detailed information for the battery is displayed Battery menu of the transmitter: Utilities>Battery

- Battery: The chemistry type of for the installed battery (Shure, Alkaline, Lithium, NiMH)
- Bars: Indicates the number of bars displayed
- Time: Battery runtime
- Charge: Percentage of charge capacity
- Health: Percentage of current battery health
- Cycle: Record of the number of charging cycles for the installed battery
- Temp: Battery temperature in Fahrenheit and Celsius

Important Tips for Care and Storage of Shure Rechargeable Batteries

Proper care and storage of Shure batteries results in reliable performance and ensures a long lifetime.

- Always store batteries and transmitters at room temperature
- Ideally, batteries should be charged to approximately 40% of capacity for long-term storage
- Periodically clean the battery contacts with alcohol to maintain ideal contact
- During storage, check batteries every 6 months and recharge to 40% of capacity as needed

For additional rechargeable battery information, visit www.shure.com.

AA Batteries and Transmitter Runtime

Transmitters are compatible with the following AA battery types:

- Alkaline
- Nickel Metal Hydride (NiMH)
- Lithium Primary

A 5-segment battery indicator representing the charge level of the transmitter battery is displayed on the screens of the transmitter and receiver. The following tables contain the approximate remaining transmitter runtime in hours:minutes.

Note: Battery runtimes vary by manufacturer, battery age, and environmental conditions.

AA Batteries and Transmitter Runtime

Alkaline

Battery Indicator	Approximate Runtime Remaining (hours:minutes)
	8:00 - 6:00
	> 4:00
	> 1:45
	≅ 1:45
	≅ 0:45
	≅ 0:15

NiMH (2700 mAh)

Battery Indicator	Approximate Runtime Remaining (hours:minutes)
	11:00 - 8:00
	> 5:00
	> 2:00
	≅ 2:00
	≅ 0:45
	≅ 0:15

Lithium Primary (3500 mAh)

Battery Indicator	Approximate Runtime Remaining (hours:minutes)
	14:00 - 10:00
	> 6:00
	> 2:00
	≅ 2:00
	≅ 0:45
	≅ 0:15

Menu Parameters

The Main menu organizes the available transmitter parameters into three categories:

- Radio
- Audio
- Utilities

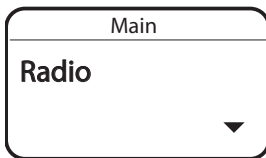

Tips for Editing Menu Parameters

- To access the menu options from the home screen, select enter. Select enter again to access the menu parameters.
- A menu parameter will blink when editing is enabled
- To increase, decrease or change a parameter, use the arrow buttons
- To save a menu change, select enter
- To exit a menu without saving a change, select exit

Menu Map

Radio

- Group Channel
- Frequency
- RF Power
- RF Output

Audio

- Offset
- MuteMode
- Tone
- Level

Utilities

- Dev ID
- Lock
- Marker
- Battery
- About
- Reset All

Radio Menu

G: and C: Group and Channel

Press the enter button to enable editing of a group (G:) or channel (C:). Use the arrow buttons to adjust the values.

Frequency

Press the enter button once to edit the first 3 digits, or twice to edit the second 3 digits.

RF Power

Higher power settings can extend the range of the transmitter.

RF Output

- On: RF signal is active
- Mute: RF signal is inactive

Audio Menu

Offset

Adjust Offset level to balance mic levels when using two bodypacks for frequency diversity.

MuteMode

When enabled, the power switch is configured as a mute switch for the audio:

- Power switch on: audio signal on
- Power switch off: audio signal muted

Tone

Transmitter will generate a continuous test tone. The tone can be set to 400 Hz or 1000 Hz.

Level

When enabled, allows for adjustment of the output level of the test tone.

Utilities Menu

Dev ID

Assign a device ID of up to 9 letters or numbers.

Lock

Locks the transmitter controls and power switch.

Marker

When enabled, press the enter button to drop a marker in Wireless Workbench.

Battery

Displays battery information:

- Battery: The chemistry type of for the installed battery (Shure Rechargeable, Alkaline, Lithium, NiMH)
- Bars: Indicates the number of bars displayed
- Time: Battery runtime
- Charge: Percentage of charge capacity
- Health: Percentage of current battery health
- Cycle: Record of the number of charging cycles for the installed battery
- Temp: Battery temperature in Fahrenheit and Celsius

About

Displays transmitter information:

- FW: Installed firmware
- HW: Hardware version
- SN: Serial number

Reset All

Restores all transmitter parameters to factory settings.

IR Sync

Use IR Sync to form an audio channel between the transmitter and receiver.

Note: The receiver band must match the band of the transmitter.

1. Select a receiver channel.
2. Tune the channel to an available frequency using group scan or manually turn to an open frequency.
3. Power on the transmitter.
4. Press the SYNC button on the receiver.
5. Align the IR windows between the transmitter and the receiver so that the IR LED illuminates red. When complete, Sync Success! appears. The transmitter and receiver are now tuned to the same frequency.

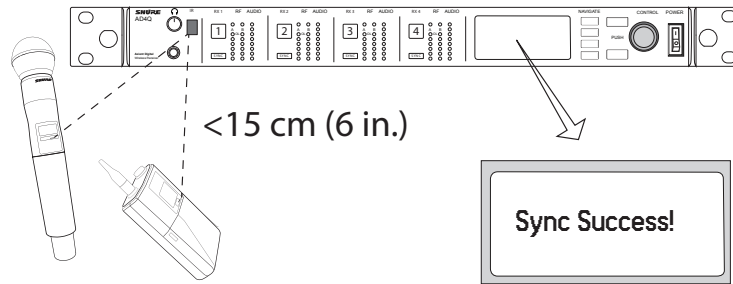
**Note:**

Any change to the encryption status on the receiver (enabling/disabling encryption) requires a sync to send the settings to the transmitter. New encryption keys for the transmitter and receiver channel are generated on every IR sync, so to request a new key for a transmitter, perform an IR sync with the desired receiver channel.

Setting the Frequency Manually

The transmitter can be manually tuned to a specific frequency, group, or channel

1. Navigate to the Radio menu.
2. To manually select a frequency, scroll to G: and C: to edit the group and channel, or to the frequency parameter .
3. Press enter to enable editing.
4. Use the \wedge \vee buttons to adjust the group, channel, or frequency.
5. Press enter to save, and then press exit when finished.

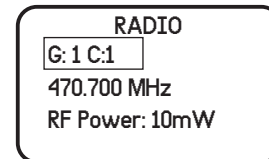

RF Mute

RF Mute prevents transmission of the audio by suppressing the RF signal, while allowing the transmitter to remain powered-on. The home screen displays RF Mute in this mode.

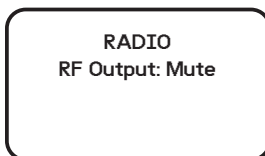

1. From the Radio menu, navigate to RF Output.
2. Choose one of the following options:
 - On: RF signal is active
 - Mute: RF signal is disabled
3. Press enter to save.

Turning the transmitter off and on, or replacing the battery will restore RF Output to On.

Power-on RF Mute

Power-on RF Mute places the transmitter in RF Mute mode immediately when turned on.

- Starting with the transmitter off, press and hold the exit button, and then switch on the power
- Continue to hold the exit button until the RF Muted message appears on the home screen

Input Overload

The OVERLOAD message is displayed when the audio input experiences a high-level input signal. Reduce the input signal or move mic away from the source to remove the overload.

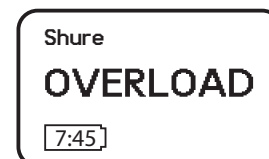

Tone Generator

The transmitter contains an internal tone generator that produces a continuous audio signal. The tone is helpful when conducting a sound check or for troubleshooting the audio signal chain. The level of the tone is adjustable from -60 dB to 0 dB and the frequency can be set to 400 Hz or 1000 Hz.

1. From the Audio menu select Tone.
2. Set the frequency to 400 Hz or 1000 Hz.
3. Select Level and use the arrow buttons adjust the value between -60 dB and 0 dB.

Tip: Always start with the level set to -60 dB to avoid overloading speakers or headphones.

Turn off the tone by selecting Off from the menu or by cycling the transmitter power.

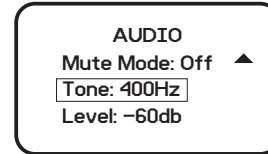

Matching Audio Levels with Offset

When linking two or more transmitters to a receiver, there may be a difference in volume levels between microphones or instruments. If this occurs, use the Offset function to match the audio levels and eliminate audible volume differences between transmitters. If using a single transmitter, set Offset to 0 dB.

1. Turn on the first transmitter and perform a sound check to test the audio level. Turn off the transmitter when finished.
2. Turn on the second transmitter and perform a sound check to test the audio level. Repeat for any additional transmitters.

3. If there is an audible difference in the sound level between the transmitters, navigate to the Offset menu (Audio>Offset) in the transmitter to increase or decrease the Offset in realtime to match the audio levels.

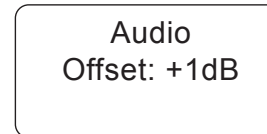

Specifications

Mic Offset Range

-12 to 21 dB (In 1 dB steps)

Battery Type

Shure SB900A Rechargeable Li-Ion or LR6 AA batteries 1.5 V

Battery Runtime

@ 10 mW

Shure SB900A	up to 9 hours
alkaline	up to 8 hours

0

Dimensions

256 mm x 51 mm (10.1 in. x 2.0 in.) L x Dia.

Weight

340 g (12.0 oz.), without batteries

Housing

Cast Aluminum

Audio Input

Configuration

Unbalanced

Maximum Input Level

1 kHz at 1% THD

145 dB SPL (SM58), typical

1

RF Output

Antenna Type

Integrated Single Band Helical

Occupied Bandwidth

<200 kHz

Modulation Type

Shure Axient Digital Proprietary

Power

2 mW, 10 mW, 35 mW

2

⁰ See Battery Runtime Chart

¹ Note: Dependent on microphone type

² See Frequency Range and Output Power table, varies by region

Frequency Bands and Transmitter RF Power

Band	Frequency Range (MHz)	RF Power (mW) ^{***}
G53	470 to 510	2/10/35
G54	479 to 565	2/10/20
G55	470 to 636*	2/10/35
G56	470 to 636	2/10/35
G57	470 to 616*	2/10/35
G62	510 to 530	2/10/35
H54	520 to 636	2/10/35
K53	606 to 698*	2/10/35
K54	606 to 663**	2/10/35
K55	606 to 694	2/10/35
K56	606 to 714	2/10/35
K57	606 to 790	2/10/35
K58	622 to 698	2/10/35
L54	630 to 787	2/10/35
R52	794 to 806	2/10/35
JB	806 to 810	2/10
X51	925 to 937.5	2/10
X55	941 to 960	2/10/35

Note: *with a gap between 608 to 614 MHz.

Note: **with a gap between 608 to 614 MHz and a gap between 616 to 653 MHz.

Note: ***power delivered to the antenna port.

Country Code	Frequency Range
Code de Pays	Gamme de frequences
Codice di paese	Gamme di frequenza
Código de país	Gama de frecuencias
Länder-Kürzel	Frequenzbereich
A, B, BG, CH, CY, CZ, D, DK, EST, F	*
FIN, GB, GR, H, HR, I, IRL, IS, L, LT	*

Country Code	Frequency Range
Code de Pays	Gamme de frequences
Codice di paese	Gamme di frequenza
Código de país	Gama de frecuencias
Länder-Kürzel	Frequenzbereich
M, N, NL, P, PL, RO, S, SK, SLO, TR	*
all other countries	*

* This equipment may be capable of operating on some frequencies not authorized in your region. See Licensing Information.

Country Code	Frequency Range
Code de Pays	Gamme de frequences
Codice di paese	Gamme di frequenza
Código de país	Gama de frecuencias
Länder-Kürzel	Frequenzbereich
A, B, BG, CH, CY, CZ, D, DK, EST, F	*
FIN, GB, GR, H, HR, I, IRL, IS, L, LT	*
M, N, NL, P, PL, RO, S, SK, SLO, TR	*
all other countries	*

* This equipment may be capable of operating on some frequencies not authorized in your region. See Licensing Information.

Country Code	Frequency Range
Code de Pays	Gamme de frequences
Codice di paese	Gamme di frequenza
Código de país	Gama de frecuencias
Länder-Kürzel	Frequenzbereich
A, B, BG, CH, CY, CZ, D, DK, EST, F	*
FIN, GB, GR, H, HR, I, IRL, IS, L, LT	*
M, N, NL, P, PL, RO, S, SK, SLO, TR	*
all other countries	*

* This equipment may be capable of operating on some frequencies not authorized in your region. See Licensing Information.

Certifications

Certified under FCC Part 74.

Certified in Canada to RSS-210.

FCC ID: DD4AD2G55, DD4AD2G57, DD4AD2K53, DD4AD2K54, DD4AD2X55. **IC:** 616A-AD2G55, 616A-AD2K53.

This device complies with Industry Canada licence-exempt RSS standard(s). Operation of this device is subject to the following two conditions: (1) this device may not cause interference, and (2) this device must accept any interference, including interference that may cause undesired operation of the

device. Le présent appareil est conforme aux CNR d'Industrie Canada applicables aux appareils radio exempts de licence. L'exploitation est autorisée aux deux conditions suivantes : (1) l'appareil ne doit pas produire de brouillage, et (2) l'utilisateur de l'appareil doit accepter tout brouillage radioélectrique subi, même si le brouillage est susceptible d'en compromettre le fonctionnement.

Meets essential requirements of the following European Directives:

- WEEE Directive 2002/96/EC, as amended by 2008/34/EC
 - RoHS Directive 2011/65/EU
- Note:** Please follow your regional recycling scheme for batteries and electronic waste

This product meets the Essential Requirements of all relevant European directives and is eligible for CE marking.

Hereby, Shure Incorporated declares that the radio equipment is in compliance with Directive 2014/53/EU. The full text of the EU declaration of conformity is available at the following internet address: <http://www.shure.com/europe/compliance>

Authorized European representative:
 Shure Europe GmbH
 Headquarters Europe, Middle East & Africa
 Department: EMEA Approval
 Jakob-Dieffenbacher-Str. 12
 75031 Eppingen, Germany
 Phone: +49-7262-92 49 0
 Fax: +49-7262-92 49 11 4
 Email: EMEAsupport@shure.de

LICENSING INFORMATION

Licensing: A ministerial license to operate this equipment may be required in certain areas. Consult your national authority for possible requirements. Changes or modifications not expressly approved by Shure Incorporated could void your authority to operate the equipment. Licensing of Shure wireless microphone equipment is the user's responsibility, and licensability depends on the user's classification and application, and on the selected frequency. Shure strongly urges the user to contact the appropriate telecommu-

nications authority concerning proper licensing, and before choosing and ordering frequencies.

Information to the user

This equipment has been tested and found to comply with the limits for a Class B digital device, pursuant to Part 15 of the FCC Rules. These limits are designed to provide reasonable protection against harmful interference in a residential installation. This equipment generates uses and can radiate radio frequency energy and, if not installed and used in accordance with the instructions, may cause harmful interference to radio communications. However, there is no guarantee that interference will not occur in a particular installation. If this equipment does cause harmful interference to radio or television reception, which can be determined by turning the equipment off and on, the user is encouraged to try to correct the interference by one or more of the following measures:

- Reorient or relocate the receiving antenna.
- Increase the separation between the equipment and the receiver.
- Connect the equipment to an outlet on a circuit different from that to which the receiver is connected.
- Consult the dealer or an experienced radio/TV technician for help.

Australia Warning for Wireless

This device operates under an ACMA class licence and must comply with all the conditions of that licence including operating frequencies. Before 31 December 2014, this device will comply if it is operated in the 520-820 MHz frequency band. **WARNING:** After 31 December 2014, in order to comply, this device must not be operated in the 694-820 MHz band.

This device complies with Industry Canada licence-exempt RSS standard(s). Operation of this device is subject to the following two conditions: (1) this device may not cause interference, and (2) this device must accept any interference, including interference that may cause undesired operation of the device.

Le présent appareil est conforme aux CNR d'Industrie Canada applicables aux appareils radio exempts de licence. L'exploitation est autorisée aux deux conditions suivantes : (1) l'appareil ne doit pas produire de brouillage, et (2) l'utilisateur de l'appareil doit accepter tout brouillage radioélectrique subi, même si le brouillage est susceptible d'en compromettre le fonctionnement.